

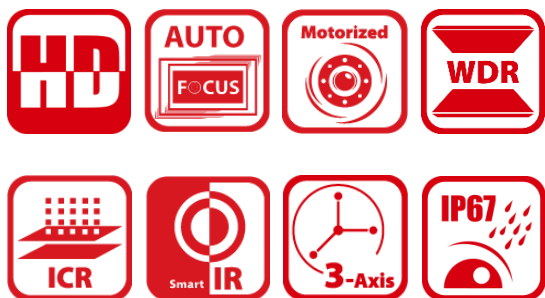

DS-2CE5AU7T-AVPIT3ZF 8 MP Dome Camera



Key Feature

- 8.29 MP high performance CMOS
- Auto focus
- 3840 × 2160 resolution
- 2.7 mm to 13.5 mm motorized varifocal lens
- EXIR 2.0, smart IR, up to 60 m IR distance
- OSD menu, 3D DNR, 130 dB true WDR
- 4 in 1 video output (switchable TVI/AHD/CVI/CVBS)
- IP67, IK10
- Up the coax (HIKVISION-C)

Specification

Camera	
Image Sensor	8.29 megapixel progressive scan CMOS
Signal System	PAL/NTSC
Frame Rate	TVI: 8MP@12.5fps, 8MP@15fps, 5MP@20fps, 4MP@25fps, 4MP@30fps, 2MP@25fps, 2MP@30fps CVI: 8MP@12.5fps, 8MP@15fps AHD: 8MP@12.5fps, 8MP@15fps CVBS: 960H P/N
Resolution	3840 (H) × 2160 (V)
Min. Illumination	Color: 0.003 Lux @ (F1.2, AGC ON), 0 Lux with IR
Shutter Time	PAL: 1/12.5 s to 1/50, 000 s NTSC: 1/15 s to 1/50, 000 s
Lens	2.7 mm to 13.5 mm motorized varifocal lens
Horizontal Field of View	108.1° to 45.6 °
Lens Mount	Ø14
Day & Night	IR cut filter
Angle Adjustment	Pan: 0° to 355°, Tilt: 0° to 75°, Rotate: 0° to 355°
Synchronization	Internal synchronization
WDR (Wide Dynamic Range)	≥ 130 dB
Menu	
AGC	Yes
D/N Mode	Auto/Color/BW (Black and White)
White Balance	Auto/Manual
BLC	Yes
WDR	Yes
Functions	Brightness, Sharpness, 3D DNR, Mirror, Smart IR
Interface	
Video Output	1 HD analog output
Switch Button	TVI/AHD/CVI/CVBS
General	
Operating Conditions	-40 °C to 60 °C (-40 °F to 140 °F), humidity: 90% or less (non-condensation)
Power Supply	9.6 VDC to 14.4 VDC; 19.2 VAC to 28.8 VAC
Power Consumption	Max. 8.2 W
Protection Level	IP67, IK10
Material	Metal
IR Range	Up to 60 m
Communication	Up the coax, Protocol: HIKVISION-C (TVI output)
Dimensions	Ø 145 mm × 111.3 mm (Ø 5.69" × 4.37")
Weight	Approx. 860 g (1.90lb.)

Order Model

DS-2CE5AU7T-AVPIT3ZF

Dimension

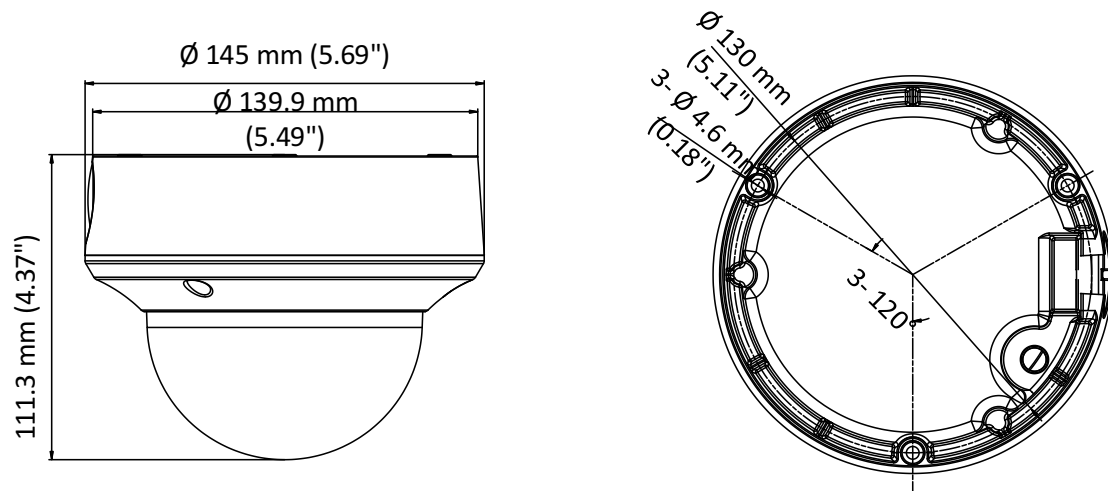

Accessory

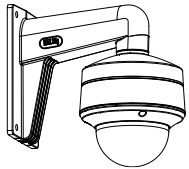

DS-1273ZJ-140-DM45
Wall Mount

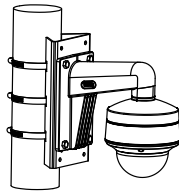

DS-1275ZJ-SUS
Vertical Pole Mount

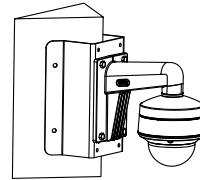

DS-1276ZJ-SUS
Corner Mount

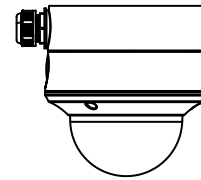

DS-1280ZJ-DM45
Junction Box

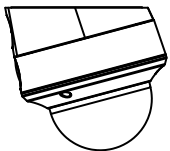

DS-1281ZJ-DM45
Inclined Ceiling Mount

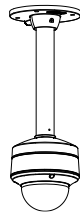

DS-1271ZJ-140-DM45
Pendant Mount