



DS-2CE56D8T1T3ZE **2 MP Ultra-Low Light POC** **Camera**



Key Feature

- 2 MP, 1920 × 1080 resolution
- Ultra-Low Light
- 130 dB true WDR, 3D DNR
- 2.7 mm to 13.5 mm varifocal lens, auto focus
- Smart IR, up to 60 m IR distance
- Power over coaxial
- IP67

Specification

Camera	
Image Sensor	2 MP CMOS
Signal System	PAL/NTSC
Frame Rate	PAL: 1080p@25fps NTSC: 1080p@30fps
Resolution	1920 (H) × 1080 (V)
Min. Illumination	0.003 Lux @ (F1.2, AGC ON), 0 Lux with IR
Shutter Time	PAL: 1/25 s to 1/50, 000 s NTSC: 1/30 s to 1/50, 000 s
Slow Shutter	Max. 16 times
Lens	2.7 mm to 13.5 mm motorized, auto focus
Horizontal Field of View	103° to 32.1°
Lens Mount	Φ14
Day & Night	ICR
WDR (Wide Dynamic Range)	≥130 dB
Angle Adjustment	Pan: 0° to 360°, Tilt: 0° to 75°, Rotate: 0° to 360°
Menu	
Image Mode	STD/HIGH-SAT
AGC	Yes
Day/Night Mode	Auto/Color/BW (Black and White)
White Balance	Auto/Manual
AE (Auto Exposure) Mode	WDR/BLC/HLC/Global
Privacy Mask	4 programmable privacy masks
Motion Detection	4 programmable motion areas
Noise Reduction	3D DNR
Language	English
Function	Brightness, Sharpness, Mirror, Smart IR
Interface	
Video Output	1 HD analog output
General	
Operating Conditions	-40 °C to 60 °C (-40 °F to 140 °F) , humidity: 90% or less (non-condensing)
Power Supply	12 VDC ± 25%/PoC.at
Power Consumption	Max. 8.2 W
Protection Level	IP67
Material	Metal
IR Range	Up to 60 m
Communication	HIKVISION-C
Dimensions	134.3 mm × 111.35 mm (5.29" × 4.38")
Weight	Approx. 610 g (1.34 lb.)

Order Model

DS-2CE56D8T-IT3ZE

Dimension

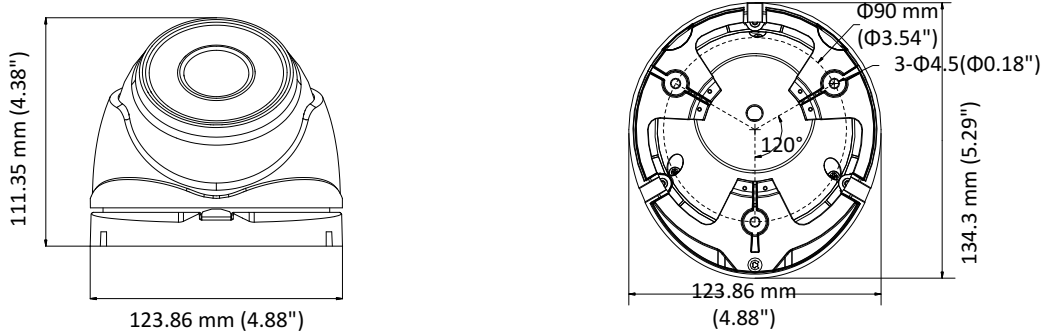

Accessory



DS-1273ZJ-130-TRL
Wall Mount



DS-1275ZJ-SUS
Vertical Pole Mount



DS-1276ZJ-SUS
Corner Mount



DS-1280ZJ-M
Junction Box



DS-1281ZJ-M
Inclined Ceiling Mount

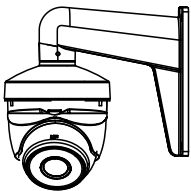

DS-1280ZJ-TR12
Wall Mount

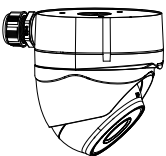
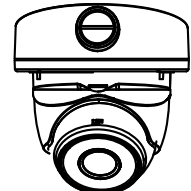
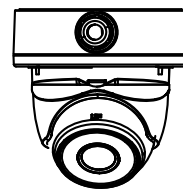
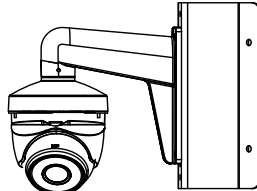
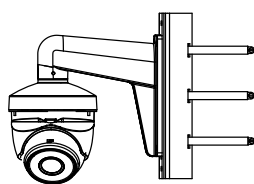

Note:

Certain accessory may not perfectly match with the camera.