

DS-1273ZJ-130(-TRL)

Wall Mounting Bracket for Dome Camera
(with adaptor plate)

Features:

- Aluminum alloy material with surface spray treatment
- The outlet hole makes the feature looks better
- Better water proof design
- Convenient installation coordinating with lower bowl

Dimension:

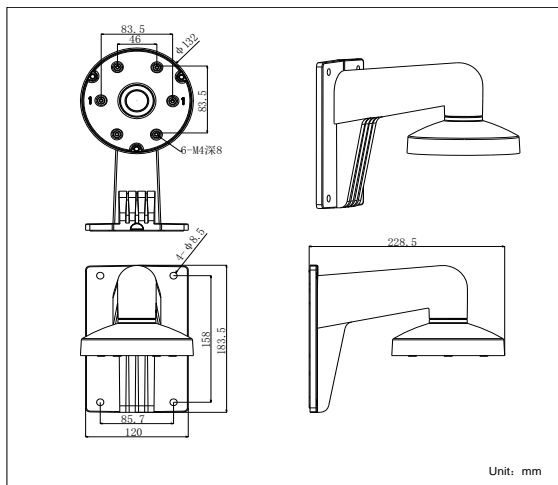

Installation Step:

- ① Choose the appropriate wall to fix the bracket and wire

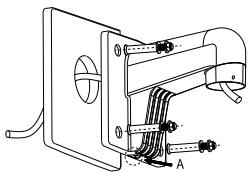

A: Cable entry hole

- ② Fix cap to bracket and complete wiring

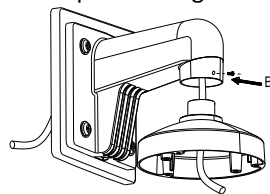

B: Fastening screw

- ③ Screw up and fix the cap

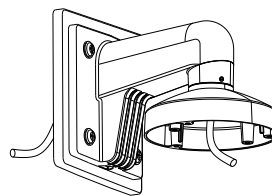

- ④ Take adaptor from the packaging of bracket

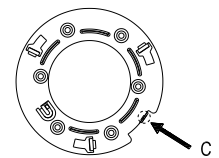

C: Bayonet of adaptor

- ⑤ Check the hole site and fix adaptor to cap

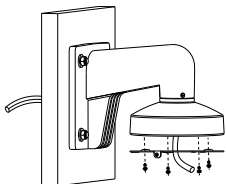

- ⑥ Connect the cable and fix dome camera to cap

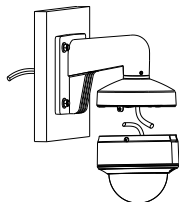

- ⑦ Rotate the dome camera moderately and screw up the fastening screw

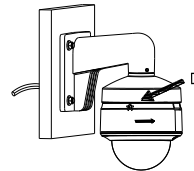

D: Fastening screw of dome camera

- ⑧ Installation complete

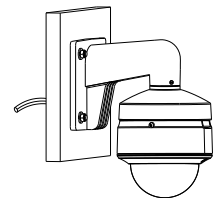

Note: The actual bracket may vary from the picture above.

Order Model:

DS-1273ZJ-130(-TRL)



Parameter:

Model	DS-1273ZJ-130(-TRL)
Parameters	Wall Mounting Bracket for Dome Camera (with adaptor plate)
Appearance	Hik White
Range of Application	Suitable for dome camera wall mounting
Material	Aluminum Alloy
Dimension	132×183.5×228.5mm
Weight	870g

Notice:

- The bracket should be installed on flat wall
- The wall must be capable of supporting over 3 times as much as the total weight of the camera and the mount.
- The maximum load capacity of the bracket is 4.5KG

Model Suitable:

DS-2CE5582P(N)-VFIR3, DS-2CE55A2P(N)-VFIR3,
DS-2CE55C2P(N)-VFIR3, DS-2CC5282P-IT3,
DS-2CC52A2P-IT3, DS-2CC5X2P(N)-IR1(IR3)
DS-2CC51X2P(N)-IR1T(IR3T), DS-2CC5182DP-IR1(IR3)
DS-2CC51X2P(N)-IR1(IR3), DS-2CD2312-I, DS-2CD2332-I